

Accessories

Collection



Cesar

Cesar: Mission-02

Accessories

Complementi per cassette e cestoni-04

Complementi per basi, colonne e pensili-32

Complementi a parete-54

Illuminazione-68

Tavoli e sostegni penisola-78



Cesar

— *Creiamo cucine
per il benessere delle
persone*

Creiamo cucine per il benessere delle persone

Il piacere di stare insieme e di essere circondati dalle cose amate sono i valori intorno ai quali si compongono le nostre case. Valori che gli arredi Cesar arricchiscono con il loro stile raffinato. Cucine dove estetica, funzionalità e qualità sono garantite dalla costante ricerca che Cesar svolge con passione da oltre quarant'anni. Cesar oggi significa cucine che nascono dall'intuizione creativa e dall'utilizzo di materiali innovativi, per ambienti sempre accoglienti e belli da vivere.

Making kitchens for People's comfort

The pleasure of spending time with loved ones, surrounded by objects you are fond of is one of the values on which our homes are founded. Values that Cesar's furniture enhances with its refined style. Kitchens in which aesthetics, functionality and quality are guaranteed by the constant research that Cesar has been conducting with passion for over forty years. Today, Cesar is synonymous of kitchens that are the outcome of creative intuition and result from the use of innovative materials for homes that are always cosy and a wonder to live in.

Nous créons des cuisines pour le bien-être des personnes

Le plaisir d'être ensemble et d'être entourés par les choses que l'on aime, telle est la valeur autour de laquelle nous composons nos intérieurs. Une valeur que les meubles Cesar enrichissent avec leur style raffiné. Des cuisines où l'esthétique, la fonctionnalité et la qualité sont garanties par la recherche que Cesar effectue, avec passion et constance, depuis plus de quarante ans. Aujourd'hui, Cesar signifie des cuisines qui naissent de l'intuition créative et de l'utilisation de matériaux innovants pour des intérieurs toujours beaux à vivre et accueillants.

Complementi per
Cassetti e cestoni

Accessories for drawers and jumbo drawers
Accessoires pour tiroirs et casseroliers



Tecnorock



Il sistema di attrezzature interne per cassetti Tecnorock è composto dal piano in acciaio inox e dai divisori in legno massello di noce o rovere scuro che rendono il prodotto esteticamente leggero ed elegante.

Il modulo dispensa offre la possibilità di personalizzare al massimo lo spazio contenitivo con accessori pratici e funzionali quali set barattoli portapasta, set contenitori inox e portapiatti regolabile.

Per cassetti e cestoni Legrabox.

The Tecnorock drawer accessory system consists of a stainless steel base and dividers in solid walnut or dark oak wood that give the product a light and elegant appeal.

The insert module allows for extreme storage customisation thanks to practical, functional accessories such as pasta jars, sets of stainless steel containers and adjustable plate racks.

For Legrabox drawers and jumbo drawers.

Le système d'aménagement intérieur pour tiroirs Tecnorock se compose d'un fond en acier inox et de séparateurs en noyer ou chêne foncé massif qui rendent l'ensemble esthétiquement léger et élégant.

L'aménagement offre la possibilité de personnaliser au maximum l'espace de rangement avec des accessoires pratiques et fonctionnels comme le set de pots à pâtes, le set de boîtes en inox et le range-assiettes réglable.

Pour tiroirs et casseroiliers Legrabox.

Per Legrabox / Antaro.

Disponibile nelle finiture:

Available in finishes:

Disponibile dans les finitions:



Massello di rovere scuro
Dark oak wood
Chêne foncé massif

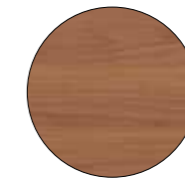

Noce
Walnut
Noyer

Tecnorock

— *Elementi / Elements / Éléments*

Portaposate / Cutlery tray / Range-couverts



A
cod. 900720 (rovere scuro)
cod. 900620 (noce)

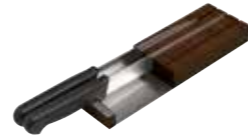

B
cod. 900721



C
cod. 900722



Accessori / Accessories / Accessoires:

- A. Portacoltelli / Knife rack / Range-couteaux
B. Portapellicola / Cling film holder / Porte-film
C. Portaspezie / Spice jars / Range-épices

Dispensa / Storage accessory / Rangement provisions

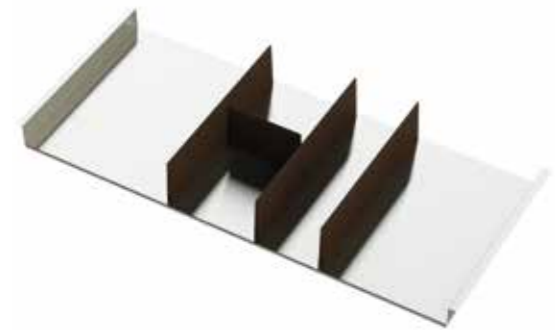

D
cod. 900723 (rovere scuro)
cod. 900623 (noce)



E
cod. 900724



F
cod. 900725 (rovere scuro)
cod. 900625 (noce)



Accessori / Accessories / Accessoires:

- D. Portapiatti / Plate rack / Range-assiettes
E. Set barattoli portapasta / Set of pasta jars / Range-pots à pâtes
F. Set contenitori inox / Set of stainless steel containers / Range-pots à pâtes rangement provisions

Tecnorock

— *Modularità / Modularity / Modularité*

Portaposate / Cutlery tray / Range-couverts

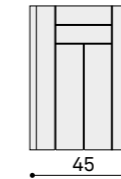
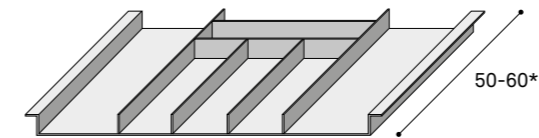

cod. 901765 / 9001785* (rovere scuro)
cod. 901665 / 9001685* (noce)

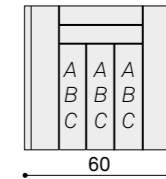

cod. 901766 / 901786* (rovere scuro)
cod. 901666 / 901686* (noce)

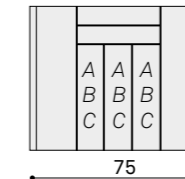

cod. 901767 / 901787* (rovere scuro)
cod. 901667 / 901687* (noce)

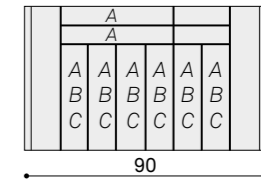

cod. 901769 / 901789* (rovere scuro)
cod. 901669 / 901689* (noce)

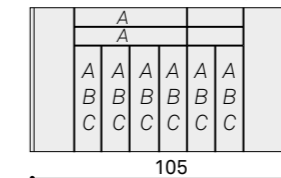

cod. 901760 / 901780* (rovere scuro)
cod. 901660 / 901680* (noce)

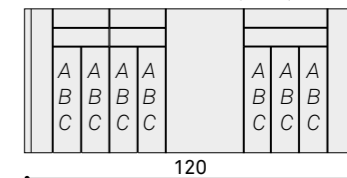

cod. 901762 / 901782* (rovere scuro)
cod. 901662 / 901682* (noce)

* La profondità 60 è costituita da un modulo prof. 50 più un compensatore da 10 cm.

The 60-cm depth is made up of a 50-cm deep module plus a 10-cm filler.

La profondeur 60 se constitue d'un module prof. 50 et d'un élément de compensation de 10 cm.

Dispensa / Storage accessory / Rangement provisions

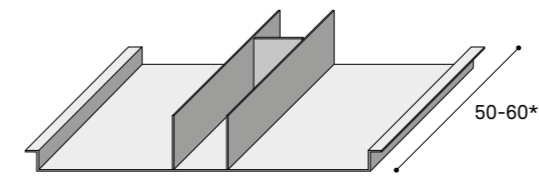

cod. 901776 / 901796* (rovere scuro)
cod. 901676 / 901696* (noce)

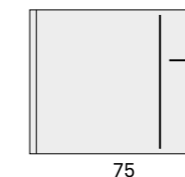

cod. 901777 / 901797* (rovere scuro)
cod. 901677 / 901697* (noce)

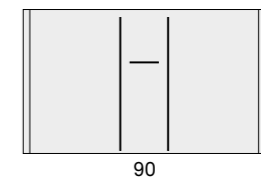

cod. 901779 / 901799* (rovere scuro)
cod. 901679 / 901699* (noce)

* La profondità 60 è costituita da un modulo prof. 50 più un compensatore da 10 cm.

The 60-cm depth is made up of a 50-cm deep module plus a 10-cm filler.

La profondeur 60 se constitue d'un module prof. 50 et d'un élément de compensation de 10 cm.



cod. 901770 / 901790* (rovere scuro)
cod. 901670 / 901690* (noce)

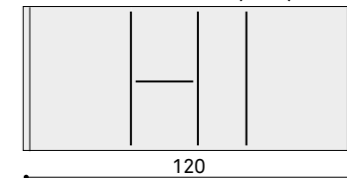

cod. 901772 / 901792* (rovere scuro)
cod. 901672 / 901692* (noce)

Fineline



Fineline è una linea di attrezzature per interni cassetto e cestone completamente in legno. La suddivisione degli spazi è organizzata secondo una logica orizzontale per minimizzare gli effetti dell'usura e degli eventuali danni che vengono prodotti dalle posate dopo numerosi cicli di chiusura/apertura del cassetto. È inoltre possibile arricchire il prodotto con una serie di pratici accessori opzionali sia per i cassetti che per la dispensa.

Per cassetti e cestoni Legrabox.

Fineline is a line of drawer and jumbo drawer accessories made entirely of wood. The spaces inside the drawer are divided and organised horizontally to minimise wear and possible damage produced by the cutlery after countless opening and closing movements. The product can also be fitted with a set of practical, optional accessories for drawers and for the storage accessory.

For Legrabox drawers and jumbo drawers.

Fineline est une ligne d'accessoires pour aménager l'intérieur des tiroirs et des casseroles, entièrement réalisée en bois. La subdivision des espaces est organisée dans le sens horizontal pour minimiser les effets de l'usure et les dommages éventuels provoqués par les couverts après de très nombreux cycles d'ouverture/fermeture du tiroir. En outre, il est possible d'enrichir l'aménagement intérieur avec une série de pratiques accessoires optionnels tant pour les tiroirs que pour le rangement des provisions.

Pour tiroirs et casseroles Legrabox.

Disponibile nelle finiture:
Available in finishes:
Disponibile dans les finitions:



Massello di rovere scuro
Dark oak wood
Chêne foncé massif



Noce
Walnut
Noyer

Fineline

— *Elementi / Elements / Éléments*

Portaposate / Cutlery tray / Range-couverts



A
cod. 900720 (rovere scuro)
cod. 900620 (noce)



B
cod. 900721



C
cod. 900722



Accessori / Accessories / Accessoires:

- A. Portacoltelli / Knife rack / Range-couteaux
B. Portapellicola / Cling film holder / Porte-film
C. Portaspezie / Spice jars / Range-épices

Dispensa / Storage accessory / Rangement provisions



D
cod. 900723 (rovere scuro)
cod. 900623 (noce)



E
cod. 900724



F
cod. 900725 (rovere scuro)
cod. 900625 (noce)



Accessori / Accessories / Accessoires:

- D. Portapiatti / Plate rack / Range-assiettes
E. Set barattoli portapasta / Set of pasta jars / Range-pots à pâtes
F. Set contenitori inox / Set of stainless steel containers / Range-pots à pâtes rangement provisions

Fineline

— *Modularità / Modularity / Modularité*

Portaposate / Cutlery tray / Range-couverts

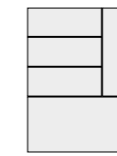
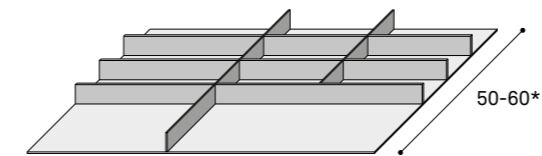

45

cod. 900765 / 900785* (rovere scuro)
cod. 900665 / 900685* (noce)

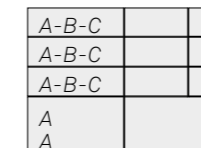

75

cod. 900767 / 900787* (rovere scuro)
cod. 900667 / 900687* (noce)

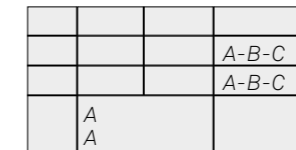

105

cod. 900760 / 900780* (rovere scuro)
cod. 900660 / 900680* (noce)

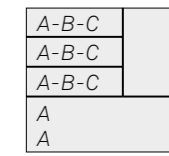

60

cod. 900766 / 900786* (rovere scuro)
cod. 900666 / 900686* (noce)

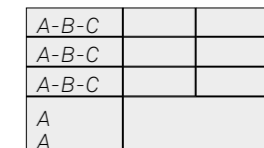

90

cod. 900769 / 900789* (rovere scuro)
cod. 900669 / 900689* (noce)

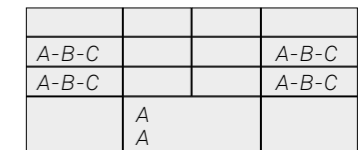

120

cod. 900762 / 900782* (rovere scuro)
cod. 900662 / 900682* (noce)

* La profondità 60 è costituita da un modulo prof. 50 più un compensatore da 10 cm.

The 60-cm depth is made up of a 50-cm deep module plus a 10-cm filler.

La profondeur 60 se constitue d'un module prof. 50 et d'un élément de compensation de 10 cm.

Dispensa / Storage accessory / Rangement provisions

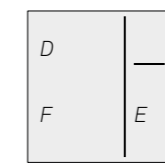
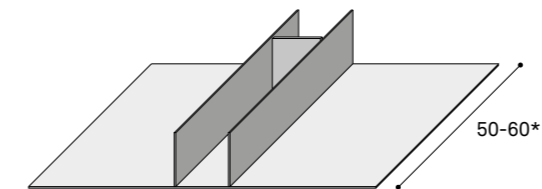

60

cod. 900776 / 900796* (rovere scuro)
cod. 900676 / 900696* (noce)



75

cod. 900777 / 900797* (rovere scuro)
cod. 900677 / 900697* (noce)

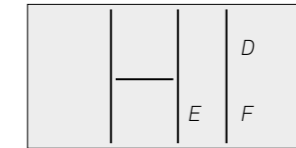

105

cod. 900770 / 900790* (rovere scuro)
cod. 900670 / 900690* (noce)



90

cod. 900779 / 900799* (rovere scuro)
cod. 900679 / 900699* (noce)



120

cod. 900772 / 900792* (rovere scuro)
cod. 900672 / 900692* (noce)

* La profondità 60 è costituita da un modulo prof. 50 più un compensatore da 10 cm.

The 60-cm depth is made up of a 50-cm deep module plus a 10-cm filler.

La profondeur 60 se constitue d'un module prof. 50 et d'un élément de compensation de 10 cm.

Ambia-line



Il programma Ambia-line è estremamente funzionale e versatile ed è pensato per abbinarsi perfettamente alle sponde dei cassetti Cesar. I telai si inseriscono rapidamente e sono posizionabili a piacere, rimanendo ben saldi alle sponde grazie alla piastra magnetica. È inoltre possibile integrare i telai con le attrezzature aggiuntive per cassetti e cestoni.

Per cassetti e cestoni Legrabox.

The Ambia-line is extremely practical and versatile. Moreover, it has been designed to perfectly suit the sides of the Cesar drawers. The frames are quick-fitting and can be positioned at will.

A magnetic plate keeps them firmly attached to the drawer sides. Additional drawer and jumbo drawer accessories can be added to the frames.

For Legrabox drawers and jumbro drawers.

Le programme Ambia-line est extrêmement fonctionnel et polyvalent et a été pensé pour s'associer parfaitement aux côtés des tiroirs Cesar.

Les casiers s'installent rapidement dans la position souhaitée en restant bien fixés aux côtés grâce à une plaque magnétique. En outre, il est possible d'allier les casiers avec les autres accessoires pour tiroirs et casseroiliers.

Pour tiroirs et casseroiliers Legrabox.

Disponibile nelle finiture:

Available in finishes:

Disponibile dans les finitions:

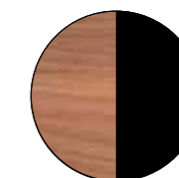

Melaminico noce Tennessee e metallo verniciato bruno
Tennessee melamine and brown painted metal
Mélaminé Tennessee et métal laqué brun

Ambia-line

— *Elementi / Elements / Éléments*

Moduli per cassetto / Modules for drawers / Modules pour tiroir

A

cod. 9916B5



B

cod. 9965B7



C

cod. 9965E1

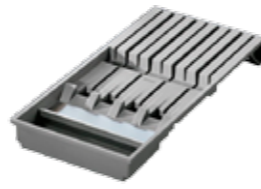

A. Portaposate / Cutlery tray / Range-couverts

B. Telaio per cassetto / Frame for drawer / Casier pour tiroir

C. Portacoltelli in finitura grigio orione / Orione grey finish knife-rack / Range-couteaux finition gris orione

D. Portapellucole in finitura grigio orione / Orione grey finish cling film holder / Porte-films finition gris orione

B

cod. 9965B4



D

cod. 9965E3



Moduli per cestone / Modules for jumbo drawers / Modules pour casserolier

E

cod. 9965D0



E

cod. 9965D4



F

cod. 9965E5



E. Telaio per cestone / Frame for jumbo drawer / Casier pour casserolier

F. Portaspezie in finitura grigio orione / Orione grey finish spice-rack / Range-épices finition gris orione

G. Portapiatti in finitura grigio orione / Orione grey finish plate-rack / Range-assiettes finition gris orione

G

cod. 9965E6

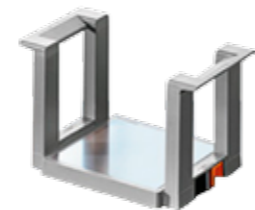

Ambia-line

— *Modularità / Modularity / Modularité*

Moduli per cassetto / Modules for drawers / Modules pour tiroir

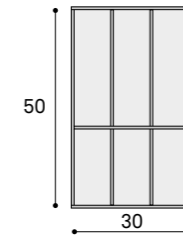
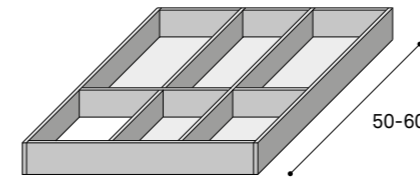

cod. 9916B5



cod. 9965B7



cod. 9965B4

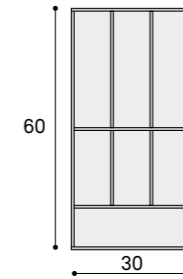

cod. 9916B6



cod. 9965B8

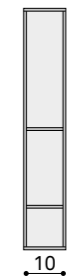

cod. 9965B5

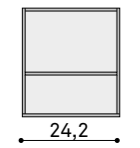

cod. 9965B0

Moduli per cestone / Modules for jumbo drawers / Modules pour casserolier

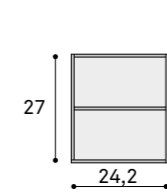
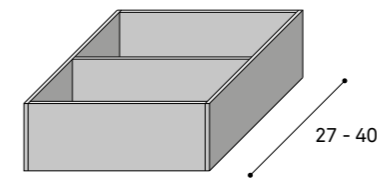

cod. 9965D0



cod. 9965D4

Premiere



Premiere è una collezione di accessori interni disegnata per allestire gli interni della cucina con materiali e linee d'avanguardia. I portaposate della collezione Première sono personalizzabili con divisori che agevolano il contenimento e con accessori aggiuntivi quali tagliere, portacoltelli e portapellicole. Il sistema dispensa in legno verniciato propone invece una serie di fasce elastiche che consentono una maggiore organizzazione dei prodotti all'interno del cestone.

Per cassetti e cestoni Legrabox.

Premiere is a collection of accessories designed to furnish the inside of kitchen cabinets with cutting-edge materials and lines. The Première collection cutlery trays can be customised with dividers that simplify storage and with additional accessories such as chopping boards, knife-racks and cling-film holders. On the other hand, the varnished wood inserts come with a set of elastic dividers that make organising storage inside jumbo drawers a lot easier.

For Legrabox drawers and jumbo drawers.

Première est une collection d'accessoires intérieurs dessinée pour aménager l'intérieur de la cuisine avec des matériaux et des lignes à l'avant-garde. Les range-couverts de la collection Première sont personnalisables avec des séparateurs qui facilitent le rangement et avec des accessoires supplémentaires comme les planches à découper, le range-couteaux et le porte-films. Le système de rangement provisions en bois verni propose, en revanche, une série de bandes élastiques qui permettent une meilleure organisation des produits à l'intérieur du casseroier.

Pour tiroirs et casseroiers Legrabox.

Disponibile nelle finiture:
Available in finishes:
Disponibile dans les finitions:



Legno verniciato Grigio Orione con fondo in laminato
Grigio Orione varnished wood with a laminate base
Bois verni Grigio Orione avec fond en stratifié

Premiere

— *Elementi / Elements / Éléments*

Portaposate / Cutlery tray / Range-couverts

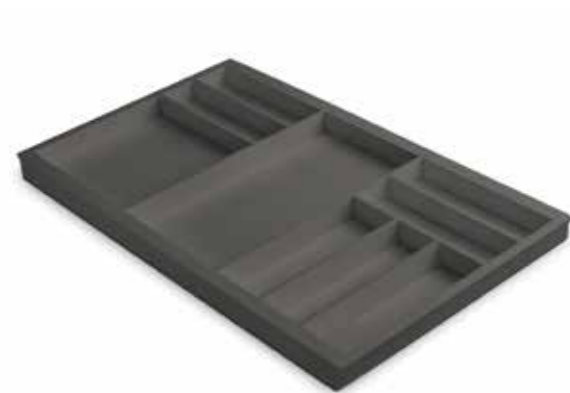

A
cod. 901212



B
cod. 901214



C
cod. 901215



D
cod. 901213



E
cod. 901211



Accessori / Accessories / Accessoires:

A. Portacoltelli / Knife rack / Range-couteaux

B. Portapellucola / Cling film holder / Porte-film

C. Portaspezie / Spice jars / Range-épices

D. Coppia taglieri / Pair of chopping boards / Paire de planches à découper

E. Inserto divisorio / Divider rack / Insert séparateur

Dispensa / Storage accessory / Rangement provisions



Accessori / Accessories / Accessoires:

F. Vasca scolapiatti / Dish-drainer tray / Bac avec égouttoir à vaisselle

G. Elementi divisorio / Dividers / Éléments de séparation

H. Fasce elastiche / Elastic dividers / Bandes élastiques

Premiere

— *Modularità / Modularity / Modularité*

Portaposate / Cutlery tray / Range-couverts

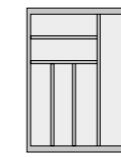
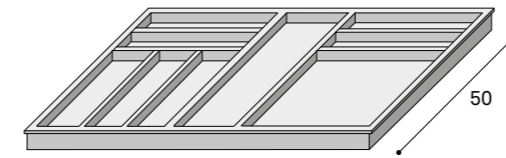

45
cod. 901205

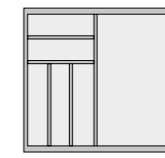

60
cod. 901206

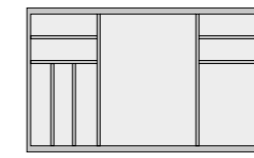

90
cod. 901209

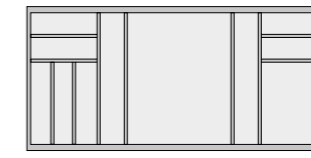

120
cod. 901202

Dispensa / Storage accessory / Rangement provisions

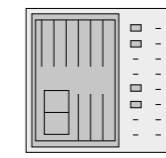
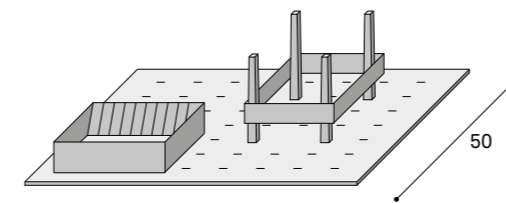

60
cod. 901226

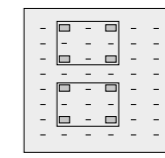

60
cod. 901229

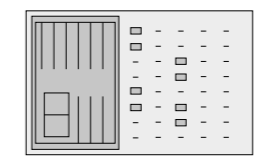

90
cod. 901222

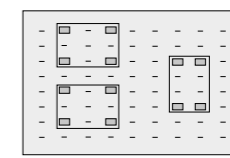

90
cod. 901236

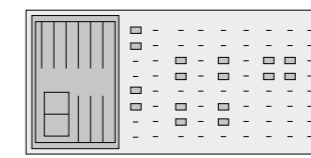

120
cod. 901239

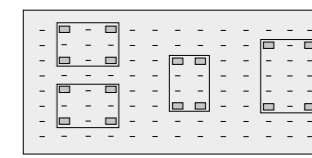

120
cod. 901232

Sky line



Sky line è un pratico sistema per organizzare il contenuto all'interno dei cassetti; è realizzato in plastica ABS, un materiale resistente e facile da pulire.

Sky line è disponibile nelle diverse lunghezze dei cassetti della gamma Cesar.

I contenitori portaposate possono essere attrezzati con dei pratici accessori aggiuntivi.

Per cassetti e cestoni Legrabox e Antaro.

Sky line is a practical way of organising the inside of your drawers. It is made from ABS plastic, a very resistant material that is easy to clean.

Sky line is available in the various widths of the Cesar range of drawers.

The cutlery trays can be fitted with practical, additional accessories.

For Legrabox and Antaro drawers and jumbo drawers.

Sky line est un système fonctionnel pour organiser le contenu des tiroirs. Il est réalisé en plastique ABS, un matériau résistant et facile à nettoyer.

Sky line est disponible dans les différentes longueurs de tiroirs de la gamme Cesar.

Les range-couverts peuvent être aménagés avec de pratiques accessoires supplémentaires.

Pour tiroirs et casseroles Legrabox et Antaro.

Disponibile nelle finiture:

Available in finishes:

Disponibile dans les finitions:

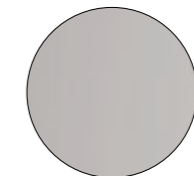

ABS finitura grigio
Grey finish ABS
ABS coloris gris

Sky line

— *Elementi / Elements / Éléments*

Portaposate / Cutlery tray / Range-couverts



A
cod. 901615



B
cod. 901616



C
cod. 901618



Accessori / Accessories / Accessoires:

- A. Inserto double face in faggio / Insert faced on both sides in beech / Insert double-face en hêtre
- B. Inserto portapellicole a 2 vani / Double cling-film insert / Insert porte-films avec 2 compartiments
- C. Inserto portaoggetti scorrevole / Sliding multi-purpose tray insert / Insert range-ustensiles coulissant

Sky line

— *Modularità / Modularity / Modularité*

Portaposate / Cutlery tray / Range-couverts

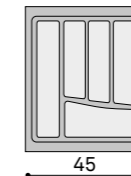
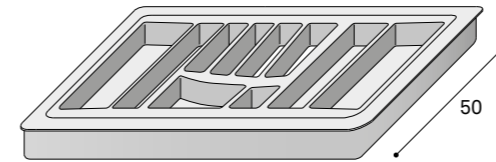

cod. 901605

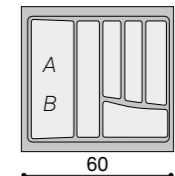

cod. 901606

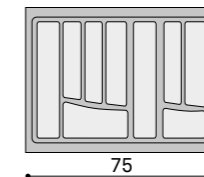

cod. 901607

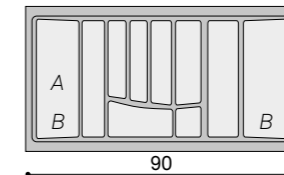

cod. 901609

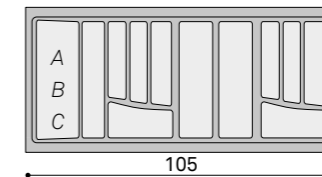

cod. 901610

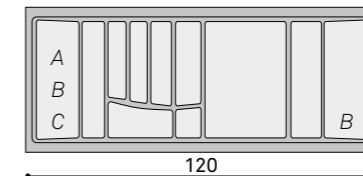

cod. 901612

Tappeto antiscivolo

— *Non-slip mat / Tapis antidérapant*



30

45 / 60 / 75 / 90 / 105 / 120

A / B / C / D / E / F

A cod. 9963I5 / B cod. 9963I6 / C cod. 9963I7
D cod. 9963I9 / E cod. 9963I0 / F cod. 9963I2



40

45 / 60 / 75 / 90 / 105 / 120

A / B / C / D / E / F

A cod. 9963J5 / B cod. 9963J6 / C cod. 9963J7
D cod. 9963J9 / E cod. 9963J0 / F cod. 9963J2

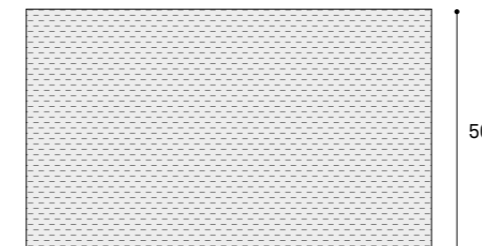

50

45 / 60 / 75 / 90 / 105 / 120

A / B / C / D / E / F

A cod. 9963K5 / B cod. 9963K6 / C cod. 9963K7
D cod. 9963K9 / E cod. 9963K0 / F cod. 9963K2

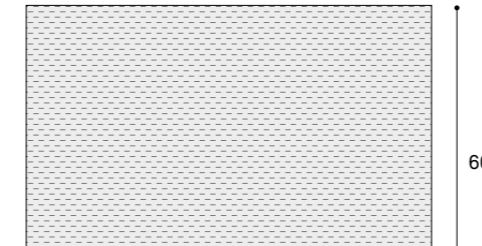

60

45 / 60 / 75 / 90 / 105 / 120

A / B / C / D / E / F

A cod. 9963L5 / B cod. 9963L6 / C cod. 9963L7
D cod. 9963L9 / E cod. 9963L0 / F cod. 9963L2

Tappetino in gomma antiscivolo, disponibile per tutte le misure di cassetti e cestoni.

Per cassetti e cestoni Legrabox.

Non-slip, rubber mat for all drawer and jumbo drawer sizes.

For Legrabox drawers and jumbo drawers.

Tapis en caoutchouc antidérapant, disponible dans toutes les dimensions de tiroirs et de casseroiliers.

Pour tiroirs et casseroiliers Legrabox.

Disponibile nelle finiture:

Available in finishes:

Disponibile dans les finitions:

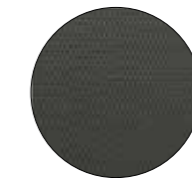

Umbr Grey

Strutture Legrabox

— *Legrabox structures / Structures Legrabox*



Tutti i cassetti e cestoni Cesar sono dotati di movimenti Legrabox, disponibili in tre finiture e in svariate modularità in larghezza, altezza e profondità. Le basi e le colonne possono essere integrate con cassetti o cestoni interni, per meglio adattarsi alle specifiche esigenze.

All Cesar drawers and jumbo drawers are fitted with the Legrabox structures available in three finishes and in various modular widths, heights and depths. Base and tall units can be fitted with interior drawers or jumbo drawers to better suit individual needs.

Tous les tiroirs et les casseroles Cesar sont dotés de structures Legrabox, déclinées en trois finitions et en plusieurs largeurs, hauteurs et profondeurs au choix. Les éléments bas et les armoires peuvent être équipés de tiroirs ou de casseroles à l'anglaise pour mieux répondre aux différents besoins de rangement.

Disponibile nelle finiture:
Available in finishes:
Disponibile dans les finitions:



Bruno

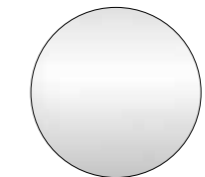

Cenere

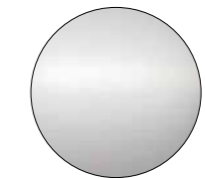

Inox

Strutture Legrabox

— Elementi / Elements / Éléments

A
Cassetto interno, con guide per basi e colonne, con o senza frontale / Interior drawer, with runners for base and tall units, with or without front / Tiroir à l'anglaise, avec coulisses pour éléments bas et armoires, avec ou sans façade



B
Cestone interno, con guide per basi e colonne, con o senza frontale / Interior jumbo drawer, with runners for base and tall units, with or without front / Casserolier à l'anglaise, avec coulisses pour éléments bas et armoires, avec ou sans façade



C
Cestone per lavello, con guide senza frontale / Shaped jumbo drawer for sink with runners, without front / Casserolier galbé pour sous-évier avec coulisses, sans façade



Strutture Legrabox

— Modularità / Modularity / Modularité

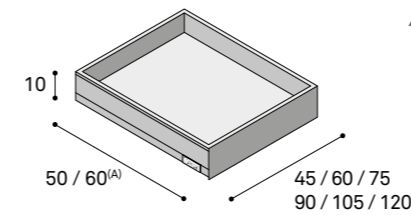

A
cod. 996MB5
cod. 996MB6
cod. 996MB7
cod. 996MB9
cod. 996MB0
cod. 996MB2
cod. 996NB5^(A)
cod. 996NB6^(A)
cod. 996NB7^(A)
cod. 996NB9^(A)
cod. 996NB0^(A)
cod. 996NB2^(A)

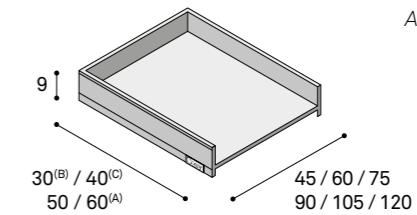

A
cod. 996L35^(B)
cod. 996L36^(B)
cod. 996L37^(B)
cod. 996L39^(B)
cod. 996L30^(B)
cod. 996L32^(B)
cod. 996K35^(C)
cod. 996K36^(C)
cod. 996K37^(C)
cod. 996K39^(C)
cod. 996K30^(C)
cod. 996K32^(C)
cod. 996M35
cod. 996M36
cod. 996M37
cod. 996M39
cod. 996M30
cod. 996M32
cod. 996N35^(A)
cod. 996N36^(A)
cod. 996N37^(A)
cod. 996N39^(A)
cod. 996N30^(A)
cod. 996N32^(A)

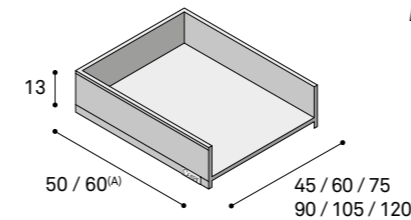

B
cod. 996M45
cod. 996M46
cod. 996M47
cod. 996M49
cod. 996M40
cod. 996M42
cod. 996N45^(A)
cod. 996N46^(A)
cod. 996N47^(A)
cod. 996N49^(A)
cod. 996N40^(A)
cod. 996N42^(A)

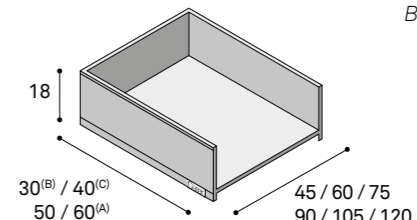

B
cod. 996L55^(B)
cod. 996L56^(B)
cod. 996L57^(B)
cod. 996L59^(B)
cod. 996L50^(B)
cod. 996L52^(B)
cod. 996K55^(C)
cod. 996K56^(C)
cod. 996K57^(C)
cod. 996K59^(C)
cod. 996K50^(C)
cod. 996K52^(C)
cod. 996M55
cod. 996M56
cod. 996M57
cod. 996M59
cod. 996M50
cod. 996M52
cod. 996N55^(A)
cod. 996N56^(A)
cod. 996N57^(A)
cod. 996N59^(A)
cod. 996N50^(A)
cod. 996N52^(A)

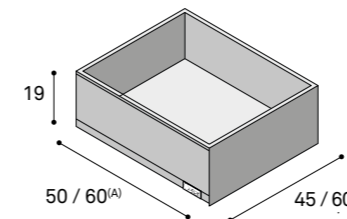

B
cod. 996MC5
cod. 996MC6
cod. 996NC5^(A)
cod. 996NC6^(A)

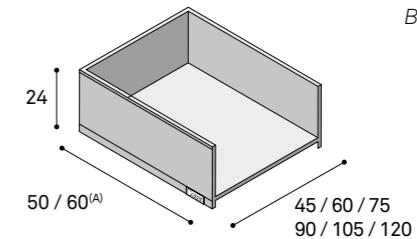

B
cod. 996M65
cod. 996M66
cod. 996M67
cod. 996M69
cod. 996M60
cod. 996M62
cod. 996N65^(A)
cod. 996N66^(A)
cod. 996N67^(A)
cod. 996N69^(A)
cod. 996N60^(A)
cod. 996N62^(A)

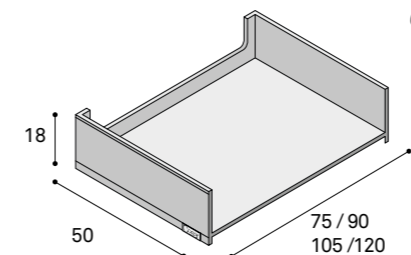

C
cod. 996M87
cod. 996M89
cod. 996M80
cod. 996M82

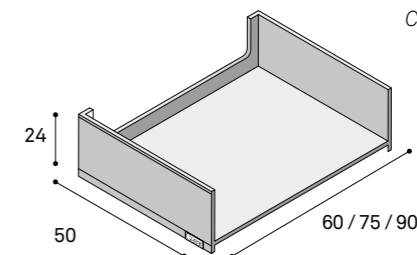

C
cod. 996M96
cod. 996M97
cod. 996M99

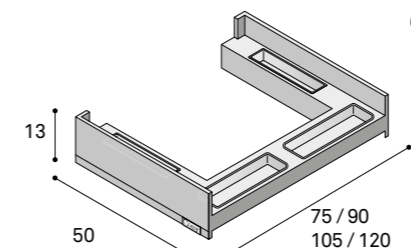

C
cod. 996M77
cod. 996M79
cod. 996M70
cod. 996M72

Complementi per
Basi, colonne e pensili

Accessories for base, tall and wall units

Accessoires pour éléments bas, éléments hauts et armoires



Pattumiere

— *Bins / Poubelles*



Pattumiera per raccolta differenziata per cestone Legrabox / Legrabox sorter bins for jumbo drawers / Poubelle pour casserolier Legrabox

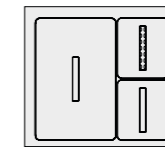

60
cod. 995646

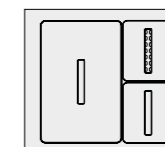

75
cod. 995647

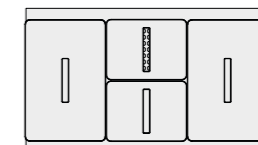

90
cod. 995649

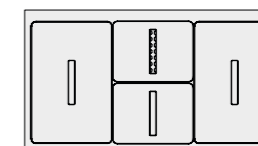

105
cod. 995640

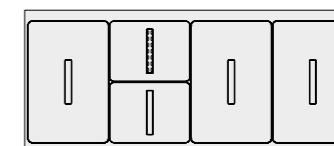

120
cod. 995642

Disponibile nelle diverse modularità di cestoni, la pattumiera è caratterizzata da coperchi in alluminio verniciato, filtro antiodore lavabile di serie, base portasecchi in alluminio verniciato in un pezzo unico.

Altezza: 26 cm.

Capacità dei contenitori: 8 lt, 12 lt, 25 lt.

Available in the various jumbo drawer sizes, the set of sorter bins comes with painted aluminium lids, a standard-supplied washable anti-odour filter and a bin base made out of a single piece of painted aluminium.

Height: 26 cm.

Capacity of each single bin: 8 l, 12 l, 25 l.

Disponibile dans les différentes modularités de casseroliers, la poubelle se distingue par des seaux avec couvercles en aluminium laqué, par un filtre anti-odeur lavable fourni en standard et par un support pour seaux en aluminium laqué réalisé en une seule plaque.

Hauteur: 26 cm.

Capacité des seaux: 8 l, 12 l, 25 l.

Pattumiere

— *Bins / Poubelles*

Pattumiera a carrello / Pullout bin / Poubelle coulissante

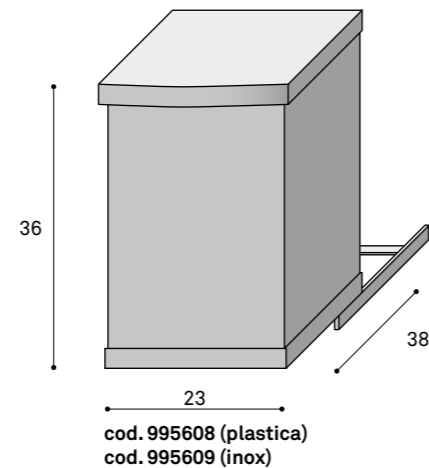

Pattumiera per raccolta differenziata estraibile da incasso, ideale per spazi ridotti. Scorrimento su guide metalliche e sollevamento automatico del coperchio all'apertura dell'anta. Disponibile in plastica bianca e in inox. Capacità di ciascun contenitore: 7 lt.

Built-in recycling sorter bin, ideal for small spaces. It runs on metal runners and the lid opens automatically when the door is opened.

Available in white plastic and stainless steel. Capacity of each single bin: 7 l.

Poubelle coulissante pour le tri sélectif, idéale pour les petits espaces. Montée sur coulisses métalliques et avec relevage automatique du couvercle à l'ouverture de la porte. Disponible en plastique blanc et en inox. Capacité de chaque seau: 7 litres.

Pattumiere

— *Bins / Poubelles*

Pattumiera per base livello ante / Waste bins for sink base unit with doors / Poubelle pour sous-évier avec portes

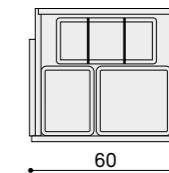

cod. 995677

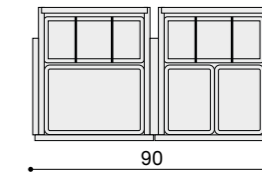

cod. 995687

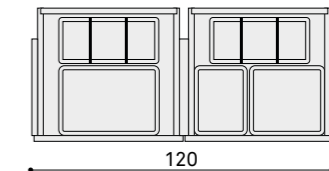

cod. 995697

Questo sistema permette di organizzare al meglio tutti gli oggetti presenti nel sottolavello e di semplificare la gestione della raccolta differenziata. I vari elementi contenitori sono facili da sganciare per meglio accedere alle utenze del sottolavello. Interamente realizzato in alluminio verniciato. Altezza: 26 cm. Capacità dei contenitori: 10 lt, 18 lt, 21 lt.

This system allows you to organise all the objects under the sink in the best possible way as well as simplifying waste sorting. The various parts can be easily removed to access the service area below the sink. The set is made entirely from painted aluminium. Height: 26 cm. Capacity of each single bin: 10 l, 18 l, 21 l.

Ce système permet d'organiser au mieux tous les objets se trouvant sous l'évier et de simplifier le tri des déchets. Les différents seaux s'enlèvent facilement pour mieux accéder aux branchements hydrauliques et électriques sous l'évier. Entièrement réalisé en aluminium laqué. Hauteur: 26 cm. Capacité des seaux: 10 l, 18 l, 21 l.

Pattumiere

— *Bins / Poubelles*

Pattumiera per base cestone estraibile Legrabox / Legrabox sorter bins for base units with jumbo drawers / Poubelle pour élément bas avec casserolier Legrabox

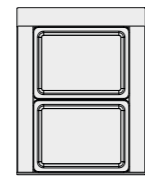

45

cod. 995625

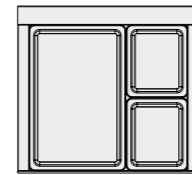

60

cod. 995626

Una soluzione da fissare direttamente sull'anta, di facile installazione.

I coperchi sono dotati di una speciale guarnizione per evitare la fuoriuscita di odori. I secchi sono interamente in metallo, della dimensione compatibile con la maggior parte dei sacchetti presenti sul mercato.

Capacità dei contenitori: 17 lt, 27 lt, 55 lt.

This bin set is easy to install because it attaches directly to the door. The lids have a special seal that prevents odours from escaping. The bins are made entirely out of metal and their size is compatible with most of the bin bags available on the market. Capacity of each single bin: 17 l, 27 l, 55 l.

Une solution qui se fixe directement à la façade du meuble, facile à installer.

Les couvercles sont dotés d'un joint particulier pour éviter les mauvaises odeurs.

Les seaux sont entièrement réalisés en métal et leurs dimensions sont compatibles avec la plupart des sacs poubelles vendus dans le commerce.

Capacité des seaux: 17 l, 27 l, 55 l.

Pattumiere

— *Bins / Poubelles*

Pattumiera per cestone Antaro / Sorter bins for Antaro jumbo drawers / Poubelle pour casserolier Antaro

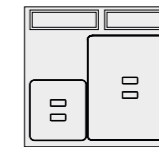

60

cod. 995674



90

cod. 995684

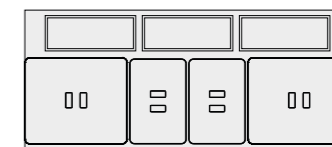

120

cod. 995694

Questo sistema permette di organizzare al meglio tutti gli oggetti presenti nel sottolavello e di semplificare la gestione della raccolta differenziata. I vari elementi contenitori sono facili da sganciare per meglio accedere alle utenze del sottolavello. Interamente realizzato in alluminio verniciato.

Altezza: 26 cm.

Capacità dei contenitori: 8 lt, 18 lt, 25 lt.

This system allows you to organise all the objects under the sink in the best possible way as well as simplifying waste sorting. The various parts can be easily removed to access the service area below the sink. The set is made entirely from painted aluminium. Height: 26 cm.

Capacity of each single bin: 8 l, 18 l, 25 l.

Ce système permet d'organiser au mieux tous les objets se trouvant sous l'évier et de simplifier le tri des déchets.

Les différents seaux s'enlèvent facilement pour mieux accéder aux branchements hydrauliques et électriques sous l'évier.

Entièrement réalisé en aluminium laqué.

Hauteur: 26 cm

Capacité des seaux: 8 l, 18 l, 25 l.

Accessori per basi

— *Basi ad angolo / Corner base units / Élément bas d'angle*



Meccanismo Magicorner per base angolo / Magicorner mechanism for corner base unit / Mécanisme Magicorner pour élément bas d'angle



cod. 990918 (dx) / cod. 990919 (sx)

Meccanismo estraibile per base angolo, con quattro cesti, fondo in melaminico bianco e struttura cromata. Disponibile nella versione destra e sinistra.

Pullout mechanism for corner base unit with four racks, a white melamine bottom panel and a chromed structure. Available in the right and left-hand versions.

Mécanisme extractible pour élément bas d'angle, avec quatre paniers dotés d'un fond en mélaminé blanc et structure chromée. Disponible en version droite ou gauche.

Meccanismo Slidecorner per base angolo / Slidecorner mechanism for corner base unit / Mécanisme Slidecorner pour élément bas d'angle



**per fusto da 90 cm: cod. 990893 (dx) / cod. 990894 (sx)
per fusto da 120 cm: cod. 990897 (dx) / cod. 990898 (sx)**

Sistema estraibile per base angolo, dotato di due cesti con fondo in melaminico bianco e struttura cromata. Disponibile nella versione destra e sinistra. Per basi ad angolo con fusto da 90 cm e 120 cm.

Pullout mechanism for corner base unit with two racks, a white melamine bottom panel and a chromed structure. Available in the right and left-hand versions. For corner base units with 90 and 120-cm carcasses.

Mécanisme extractible pour élément bas d'angle, avec deux plateaux dotés d'un fond en mélaminé blanc et structure chromée. Disponible en version droite ou gauche. Pour éléments bas d'angle avec caisson de 90 cm et de 120 cm.

Accessori per basi

— *Basi ad angolo / Corner base units / Élément bas d'angle*

Girelli per base angolo / Carousel baskets for corner base unit / Paniers demi-lune pour élément bas d'angle

Coppia girelli con piantone per base angolo / Pair of carousel baskets with stand for corner base unit / Paire de paniers tourniquets avec mât pour élément bas d'angle



per anta da 45 cm: cod. 990821 (dx) / cod. 990822 (sx)
per anta da 60 cm: cod. 990823 (dx) / cod. 990824 (sx)

Sistema girevole con due cesti con fondo in melaminico. Disponibile nella versione destra e sinistra. Per basi ad angolo con anta da 45 cm e 60 cm.

Carousel mechanism with two racks with melamine bases. Available in the right and left-hand versions. For corner base units with 45 and 60-cm doors.

Système pivotant avec deux plateaux dotés de fond mélaminé. Disponible en version droite ou gauche. Pour éléments bas d'angle avec porte de 45 cm et de 60 cm.



cod. 990814 (270°) / cod. 990818 (360°)

Sistema girevole con due cesti in filo cromato. Per basi ad angolo 90x90 cm a libro.

Carousel mechanism with two chromed wire baskets. For 90x90-cm corner base units with bi-folding doors.

Système pivotant avec deux paniers en fil chromé. Pour éléments bas d'angle de 90x90 cm avec porte pliante.

Accessori per basi

— *Basi ad angolo / Corner base units / Élément bas d'angle*

Meccanismo per basi angolo Revo 90° / Mechanism for 90° Revo corner base units / Mécanisme élément bas d'angle Revo 90°



cod. 991970

Meccanismo per basi angolo con cestelli girevoli cromati e fondo in melaminico bianco. I ripiani regolabili in altezza permettono di sfruttare in modo ottimale lo spazio.

Mechanism for corner base units with chromed carousel baskets and white melamine bottom panels. The height-adjustable shelves favour optimal space exploitation.

Mécanisme pour éléments bas d'angle avec plateaux pivotants chromés dotés de fond en mélaminé blanc. Les plateaux réglables en hauteur permettent d'exploiter l'espace intérieur de façon optimale.



Accessori per basi

— *Complementi / Accessories / Accessoires*

Carrello estraibile cromato / Chrome pullout rack / Panier coulissant chromé



per base: cod. 990907
per pensile: cod. 990908

Carrello estraibile con struttura cromata e fondo in melaminico bianco, a estrazione totale e chiusura soft. Per basi o pensili da 15 cm.

Full-extension, soft-close pullout rack with chromed structure and white melamine bottom panel. For 15-cm base or wall units.

Structure coulissante chromée avec paniers avec fond en mélaminé blanc, à sortie totale et avec fermeture soft. Pour éléments bas ou hauts de 15 cm.

Carrello estraibile cromato / Chrome pullout rack / Panier coulissant chromé



cod. 990902

Carrello estraibile con struttura cromata e fondo in melaminico bianco, a estrazione totale e chiusura soft. Per basi da 30 cm.

Full-extension, soft-close pullout rack with chromed structure and white melamine bottom panel. For 30-cm base units.

Structure coulissante chromée avec paniers avec fond en mélaminé blanc, à sortie totale et avec fermeture soft. Pour éléments bas de 30 cm.

Accessori per basi

— *Complementi / Accessories / Accessoires*

Carrello portapane / Bread bag rack / Panetière coulissante



cod. 990912

Carrello portapane con struttura cromata, fondo in melaminico bianco, busta portapane in tela, a estrazione totale e chiusura soft. Per basi da 30 cm.

Full-extension, soft-close bread bag rack with chromed structure, fabric bread bag and white melamine bottom panel. For 30-cm base units.

Structure panetière coulissante chromée avec paniers avec fond en mélaminé blanc et sac à pain en toile, à sortie totale et avec fermeture soft. Pour éléments bas de 30 cm.

Cesto portadetersivo / Detergent rack / Range-détersifs

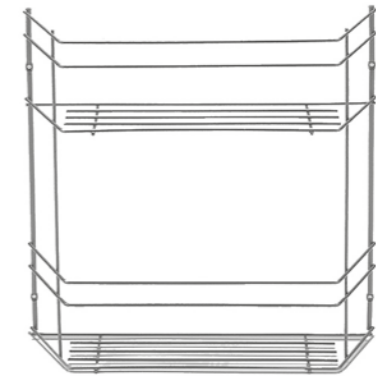

cod. 995900

Cesto portadetersivo in filo cromato, da applicare sul retro dell'anta. Dimensioni (LxPxH): 35x10x34 cm.

Chromed wire detergent rack, designed to be applied to the back of the door. Dimensions (wxdxh): 35x10x34 cm.

Panier range-détersifs en fil chromé se fixant au dos de la porte. Dimensions (LxPxH): 35x10x34 cm.

Accessori per colonne

— *Complementi / Accessories / Accessoires*



Meccanismo "Convoy" estraibile per colonna / "Convoy"
slide-out storage system for tall units / Mécanisme
extractible "Convoy" pour armoire



H. 138: cod. 991980 (dx) / cod. 991981 (sx)
H. 198, 210, 222: cod. 991985 (dx) / cod. 991986 (sx)

Il meccanismo estraibile fuoriesce automaticamente all'apertura dell'anta; i prodotti posizionati sui ripiani sono in questo modo fruibili su tre lati.
Finitura metallo antracite.
Disponibile per colonne h. 138, 198, 210, 222 cm.
Per colonne l. 60 cm.

The mechanism slides out automatically when the door is opened and the products can be accessed from three sides.
Anthracite metal finish.
Available for 138, 198, 210, 222 cm high tall units.
For 60 cm wide tall units.

Le mécanisme extractible sort automatiquement d'une armoire lorsque l'on ouvre la porte. Il est ainsi possible d'accéder aux produits rangés sur les tablettes sur trois côtés.
Finition métal anthracite.
Disponibile pour armoires h. 138, 198, 210 et 222 cm.
Pour armoires l. 60 cm.

Meccanismo "Tandem" estraibile per colonna / "Tandem"
slide-out storage system for tall units / Mécanisme
extractible "Tandem" pour armoire



H. 138: cod. 991925 (45 cm) / cod. 991926 (60 cm)
H. 138 2 ante: cod. 991929 (90 cm) / cod. 991922 (120 cm)
H. 198, 210, 222: cod. 991955 (45 cm) / cod. 991956 (60 cm)

Meccanismo estraibile per colonne, finitura metallo cromato e fondo in melaminico. I ripiani posteriori avanzano verso la posizione dell'osservatore.
Chiusura soft.
Disponibile per colonne h. 138, 198, 210, 222 cm.
Per colonne l. 45, 60 cm.

Pullout mechanism for tall units with a chromed metal finish and a melamine base. The rear shelves move towards the user. Soft-close mechanism.
Available for 138, 198, 210, 222 cm high tall units.
For W. 45 and 60 cm tall units.

Mécanisme extractible pour armoires, finition métal chromé et fond en mélaminé. Les tablettes arrière avancent vers la position de l'utilisateur. Fermeture soft.
Disponibile pour armoires h. 138, 198, 210 et 222 cm.
Pour armoires l. 45 et 60 cm.

Accessori per colonna

— *Complementi / Accessories / Accessoires*

Set accessori per colonna portascoppe / Set of accessories for broom cupboard / Lot accessoires pour armoire range-balais



cod. 995635

Set accessori per colonne portascoppe composto da:

- 1 supporto porta elettrodomestici,
- 1 scaffale (40,5x21x90 cm),
- 1 cesto porta detersivi (36x10x8 cm),
- 2 listelli con 5 ganci.

Set of accessories for broom cupboard, composed of:

- 1 household appliance support,
- 1 rack (40,5x21x90 cm),
- 1 detergent rack (36x10x8 cm),
- 2 rods with 5 hooks.

Lot accessoires pour armoire range-balais se composant de:

- 1 support pour aspirateur,
- 1 rayonnage de 40,5x21x90,
- 1 panier range-détersifs de 36x10x8,
- 2 barres avec 5 crochets.

Carrello estraibile per colonna / Pullout rack for tall unit / Structure coulissante pour armoire



H. 138: cod. 990926 (30 cm) / cod. 990927 (45 cm) / cod. 990928 (60 cm). H. 198, 210, 222: cod. 990932 (30 cm) / cod. 990933 (45 cm) / cod. 990934 (60 cm)

Meccanismo estraibile per colonne, con cesti in metallo cromato e fondo in melaminico. Chiusura soft. Disponibile per colonne h. 138, 198, 210, 222 cm. Per colonne l. 30, 45, 60 cm.

Pullout rack for tall unit, with chrome metal racks and melamine bottom panel. Soft-close mechanism. Available for tall units h. 138, 198, 210, 222 cm. For tall units l. 30, 45, 60 cm.

Structure coulissante chromée pour armoire avec fond en mélaminé. Fermeture soft. Disponible pour armoires en hauteurs 138, 198, 210, 222 cm. Pour armoires l. 30, 45, 60 cm.

Accessori per colonna

— *Complementi / Accessories / Accessoires*

Carrello "Dispensa" estraibile cromato / Chrome "Dispensa" pullout rack / Structure "Dispensa" coulissante pour armoire



H. 138: cod. 991913 (30 cm) / cod. 991915 (45 cm)
H. 198, 210, 222: cod. 991943 (30 cm) / cod. 991945 (45 cm)

Carrello estraibile per colonna con meccanismo in metallo. Le vaschette regolabili in altezza garantiscono una facilità e semplicità di accesso. Per colonne l. 30 e 45 cm. Disponibile per colonne di altezza 138, 198, 210, 222 cm.

Pullout rack for tall unit with metal mechanism. The height-adjustable shelves ensure easy access. For W. 30 and 45 cm tall units. Available for 138, 198, 210, 222 cm high tall units.

Outre la possibilité de régler les tablettes en hauteur, l'aménagement Swing peut, en sortie totale, pivoter des deux côtés sur son axe pour mieux accéder aux tablettes. Pour armoires l. 30 et 45 cm. Disponible pour armoires en hauteurs 198, 210 et 222 cm.

Carrello "Swing" estraibile cromato / Chrome "Swing" pullout rack / Structure "Swing" coulissante pour armoire



H. 198, 210, 222: cod. 991963 (30 cm) / cod. 991965 (45 cm)

Oltre ai ripiani regolabili in altezza, quando è completamente estratta, la dispensa Swing può essere fatta girare attorno al proprio asse, per un migliore accesso ai ripiani. Per colonne l. 30 e 45 cm. Disponibile per colonne di altezza 198, 210, 222 cm.

In addition to being height-adjustable, when it is completely open the Swing mechanism can rotate around its axis, making the shelves easy to access. For W. 30 and 45 cm tall units. Available for 198, 210, 222 cm high tall units.

Outre la possibilité de régler les tablettes en hauteur, l'aménagement Swing peut, en sortie totale, pivoter des deux côtés sur son axe pour mieux accéder aux tablettes. Pour armoires l. 30 et 45 cm. Disponible pour armoires en hauteurs 198, 210 et 222 cm.

Accessori per colonna

— *Colonne ad angolo / Corner tall units / Armoires d'angle*

Meccanismo Sidecorner per colonna angolo / Slidecorner mechanism for corner tall unit / Mécanisme Slidecorner pour armoire d'angle



per fusto da 90 cm: cod. 990973 (dx) / cod. 990974 (sx)
per fusto da 120 cm: cod. 990975 (dx) / cod. 990976 (sx)

Sistema estraibile per colonne angolo, con quattro cesti cromati e fondo in melaminico bianco. Disponibile nelle versioni destra e sinistra e per colonne con fusti da 90 e 120 cm.

Pullout mechanism for corner tall unit with four chromed racks and white melamine bottom panels. Available in the right and left-hand versions and for tall units with 90 and 120-cm carcasses.

Système extractible pour armoires d'angle, avec quatre plateaux chromés dotés de fond en mélaminé blanc. Disponible en version droite ou gauche et pour armoires avec caissons de 90 et de 120 cm.

Accessori per pensili

— *Scolapiatti / Dish drainer rack / Égouttoir à vaisselle*

Scolapiatti un piano / One-tier dish drainer rack / Égouttoir à vaisselle à 1 étage



cod. 994751 (41,3 cm) / cod. 994761 (56,3 cm) / cod. 994771 (71,3 cm)
cod. 994791 (86,3 cm) / cod. 994711 (101,3 cm) / cod. 994721 (116,3 cm)

Rastrelliera inox un piano, con raccogliacqua e telaio. È dotata di supporti in materiale plastico trasparente, atossico e lavabile in lavastoviglie. Questi supporti possono essere spostati con una semplice pressione per organizzare al meglio le stoviglie. Per pensili altezza 36 e 48 cm. Disponibile nelle larghezze da 45 a 120 cm.

One-tier stainless steel dish-rack with drip tray and frame. It has non-toxic, dishwasher-safe, transparent plastic supports. The position of these supports can be adjusted for excellent dish organisation by simply pressing on them. For 36 and 48-cm high wall units. Available from 45 to 120 cm wide.

Égouttoir en inox à 1 étage avec plateau de récupération eau et cadre. Il est doté de supports en plastique transparent, atoxique et lavable en lave-vaisselle. Ces supports peuvent se déplacer en exerçant une simple pression pour ranger au mieux la vaisselle lavée. Pour éléments hauts en hauteurs 36 et 48 cm. Disponible dans les largeurs de 45 à 120 cm.

Accessori per pensili

— *Scolapiatti / Dish drainer rack / Égouttoir à vaisselle*

Scolapiatti due piano / Two-tier dish drainer rack / Égouttoir à vaisselle à 2 étages



cod. 994740 (36,3 cm) / cod. 994750 (41,3 cm) / cod. 994760 (56,3 cm) / cod. 994770 (71,3 cm)
cod. 994790 (86,3 cm) / cod. 994710 (101,3 cm) / cod. 994720 (116,3 cm)

Rastrelliera inox due piani, con raccogliocce e telaio. Semplice e veloce da installare, interamente in acciaio inox. Garantisce una grande stabilità ed evita il pericolo delle flessioni a pieno carico.

Per pensili di altezza superiore a 48 cm.
Disponibile nelle larghezze da 45 a 120 cm.

Two-tier stainless steel dish rack with drip tray and frame. Quick and easy to install, this dish-drainer is entirely in stainless steel. It ensures excellent stability and does not bend under a full load.

For wall units higher than 48 cm.
Available from 45 to 120-cm wide.

Égouttoir en inox à 2 étages avec plateau de récupération eau et cadre. Simple et rapide à installer, entièrement réalisé en acier inox. Il assure une grande stabilité et évite tout risque de fléxion lorsqu'il est chargé.

Pour éléments hauts avec une hauteur supérieure à 48 cm.
Disponibile dans les largeurs de 45 à 120 cm.

Accessori per pensili

— *Scolapiatti / Dish drainer rack / Égouttoir à vaisselle*

Scolapiatti due piani ad angolo / Dish drainer rack for corner, two tiers / Égouttoir à vaisselle en inox d'angle à 2 étages



cod. 994799 (63,2 x 63,2 cm) / cod. 994798 (73,2 x 73,2 cm)

Rastrelliera inox versione ad angolo, due piani, con raccogliocce e telaio. Semplice e veloce da installare, interamente in acciaio inox.

Per pensili di altezza superiore a 48 cm.
Disponibile per pensili angolo l. 65, 75 cm.

2-tier corner stainless steel dish drainer rack with drip tray and frame. Quick and easy to install, this dish-drainer is entirely in stainless steel.

For wall units higher than 48 cm.
Available for 65 and 75 cm wide wall units.

Égouttoir en inox à 2 étages en version d'angle, avec plateau de récupération eau et cadre. Simple et rapide à installer, entièrement réalisé en acier inox.

Pour éléments hauts avec une hauteur supérieure à 48 cm.
Disponibile pour éléments hauts d'angle l. 65 et 75 cm.

Complementi a
Parete

Wall accessories

Compléments à fixer au mur



Wall Waiter — *Design García Cumini*



Wall Waiter è un innovativo modulo polifunzionale. Contiene e organizza molti oggetti della cucina. Il frontale a ribalta lo trasforma in un piano d'appoggio supplementare mentre la luce led integrata illumina sia il piano che gli accessori più utilizzati. I moduli possono vivere singolarmente, in linea o in colonna, per una massima progettualità.

Wall Waiter is an innovative multi-functional module that can hold and organise many of the objects used in the kitchen. The pull-down front becomes an extra shelf while the integrated led light illuminates the worktop and the accessories used most frequently. The modules can be used on their own, in a line or one on top of the other for utmost planning freedom.

Wall Waiter est un innovant module polyfonctionnel. Il permet de ranger et d'organiser de nombreux objets de la cuisine. Quand on ouvre la façade abattante, celle-ci se transforme en un plan de dépose supplémentaire alors que l'éclairage à leds incorporé illumine le plan de travail et les accessoires les plus utilisés. Les modules peuvent s'installer individuellement, s'aligner ou se superposer et offrent une liberté d'agencement maximale.



Disponibile nelle finiture:
Available in finishes:
Disponibile dans les finitions:

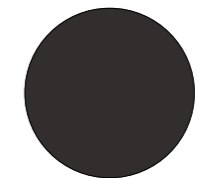

Titanio

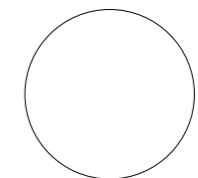

Bianco

Wall Waiter

— Accessori / Accessories / Accessoires

- A. Gancio per barra Quadro / Hooks for bar Quadro / Supports et embouts pour barre Quadro
 B. Ganci per barra Uncino / Hooks for bar Uncino / Supports et embouts pour barre Uncino
 C. Luci a led (2700 - 4000 K) / Led Light (2700/4000 K) / Éclairage à leds (2700 / 4000 K)



Quadro
A *



Uncino
B *







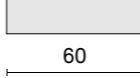
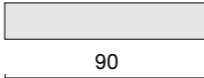
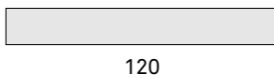
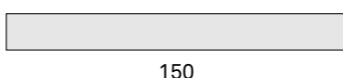







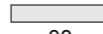

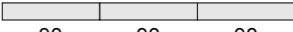





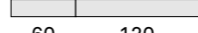

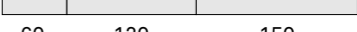

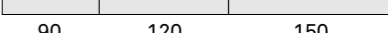
* Disponibili in ottone finitura Inox satinato PVD (Physical Vapor Deposition) che garantisce una resistenza all'abrasione superiore rispetto ad altri trattamenti. / Available in brass with a PVD (Physical Vapor Deposition) satin stainless steel finish that guarantees greater resistance to abrasion than other treatments. / Disponibles en laiton finitura Inox satiné PVD (Physical Vapor Deposition) qui assure une résistance à l'abrasion supérieure par rapport aux autres traitements.

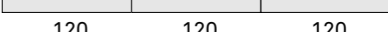
Wall Waiter

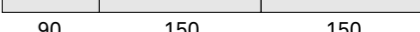
— Modularità / Module sizes / Modularité

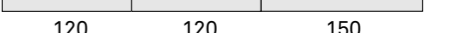
	cod. 099WWB06 (bianco) cod. 099WWT06 (titanio)	Ganci di serie / Standard hooks / Crochets standard 2 (1A+1B)
	cod. 099WWB09 (bianco) cod. 099WWT09 (titanio)	Ganci di serie / Standard hooks / Crochets standard 4 (2A + 2B)
	cod. 099WWB12 (bianco) cod. 099WWT12 (titanio)	Ganci di serie / Standard hooks / Crochets standard 6 (3A + 3B)
	cod. 099WWB15 (bianco) cod. 099WWT15 (titanio)	Ganci di serie / Standard hooks / Crochets standard 8 (4A + 4B)
 	cod. 099WWA00	Kit ganci / Kit Hooks / Crochets kit 4 (2A + 2B)

— Componibilità / Modularity / Compositions

60 cm		60	270 cm	
90 cm		90		
120 cm		120		
		60 60		
150 cm		150	300 cm	
		60 90		
180 cm		60 120	330 cm	
		90 90		
		60 60 60	360 cm	
210 cm		60 150		
		90 120	390 cm	
		120 120		
240 cm		120 60 60	420 cm	
		90 150	450 cm	

Barre attrezzate

— Serie filo cromato / Chromed wire line / Série fil chromé



Accessori / Accessories / Accessoires:

- A. Tubo portagadget / Accessory hanging rail / Barre de crédence
- B. Portascottex / Kitchen roll holder / Porte-essuie-tout
- C. Portaspezie / Spice rack / Porte-épices
- D. Portabarattoli / Jar shelf / Porte-pots

A
cod. 994110



B
cod. 994150



C
cod. 994160



D
cod. 994130



Disponibile nelle finiture:
Available in finishes:
Disponibile dans les finitions:

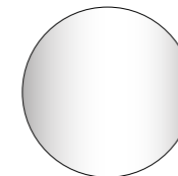

Cromato
Chromed
Chromée

Barre attrezzate

— Serie Titan / Titan line / Série Titan



Accessori / Accessories / Accessoires:

- A. Barra portagadget / Accessory hanging bar / Barre de crédence
- B. Ganci per barra / Hooks for bar / Supports et embouts pour barre
- C. Mensola con staffe, disponibile nelle lunghezze 35 e 50 cm / Shelf with brackets, available for 35 and 50 cm lengths / Étagère en aluminium avec supports, disponible en longueur 35 et 50 cm
- D. Mensola portarotolo / Kitchen roll holder / Étagère porte-rouleau

A

cod. 994040 (inox)
cod. 994060 (bruno)



B

cod. 994042 (inox)
cod. 994062 (bruno)



C

l. 35 cm:
cod. 994043 (inox)
cod. 994063 (bruno)

l. 50 cm:
cod. 994044 (inox)
cod. 994064 (bruno)



D

cod. 994045 (inox)
cod. 994065 (bruno)

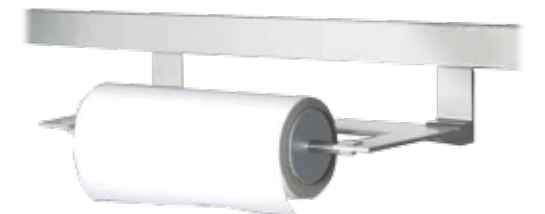

Disponibile nelle finiture:
Available in finishes:
Disponibile dans les finitions:

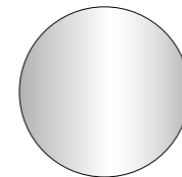

Finitura inox
Stainless steel finish
Finition inox

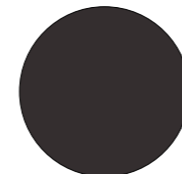

Alluminio bruno
Brown aluminium
Aluminium brun

Barre attrezzate

— Serie Linero Mosaiq / Linero Mosaiq line / Série Linero Mosaiq



Accessori / Accessori / Accessoires:

- A. Profilo portagadget / Accessory hanging bar / Barre de crédence
- B. Mensola porta oggetti / Multi purpose shelf / Étagère porte-objets
- C. Mensolina superiore / Top shelf / Étagère supérieure
- D. Ripiani decorativi per mensoline C o lavagnetta F / Decorative shelf covers for shelves C or board F / Tablettes décoratives pour étagère C ou tableau F
- E. Portacoltelli con inserto in legno e magneti per fissaggio lame / Knife-rack with wooden insert and magnets to secure the blades / Range-couteaux avec insert en bois et aimants pour fixation des lames
- F. Mensola con lavagnetta magnetica / Shelf with magnetic board / Étagère avec tableau magnétique
- G. Portarotoli singolo / Single kitchen roll holder / Porte-rouleaux simple
- H. Portarotoli doppio / Double kitchen roll holder / Porte-rouleaux double
- I. Contenitore magnetico / Magnetic container / Connecteur magnétique
- L. Mensola a due ganci / Shelf with two hooks / Étagère avec deux crochets

Disponibile nelle finiture:
Available in finishes:
Disponible dans les finitions:

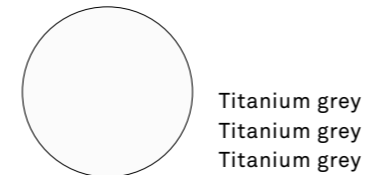

Titanium grey
Titanium grey
Titanium grey

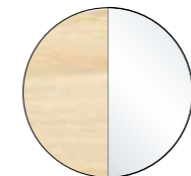

Legno / Vetro
Wood / Glass
Bois / Verre

A
cod. 994186 (60 cm)
cod. 994189 (90 cm)
cod. 994182 (120 cm)
cod. 994185 (150 cm)

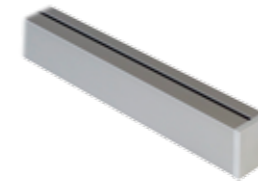

B
cod. 994194



C
cod. 994196



D
cod. 994198
cod. 994199



E
cod. 994190



F
cod. 994197



G
cod. 994191



H
cod. 994192



I
cod. 994193



L
cod. 994195





Barre attrezzate

— Barra elettrificata / Power strip / Barre électrifiée

Accessori / Accessories / Accessoires:

- A. Power truck, l.40 cm / Power truck, l.40 cm / Power truck, l.40 cm
- B. Coperchio di chiusura frontale in alluminio opaco / Matt aluminium front cover / Couvercle avant en aluminium mat
- C. Adattatore - interruttore 16A, standard italiano / 16A adaptor - switch, standard Italian / Adaptateur-interrupteur 16A, standard italien
- D. Adattatore - interruttore 16A, standard tedesco / 16A adaptor - switch, standard German / Adaptateur-interrupteur 16A, standard allemand
- E. Adattatore - interruttore 16A, standard Euro 2Pin, Australia, Cina, India, USA, Japan, GB/UK, Schuko / 16A adaptor - switch, standard European 2-prong, Australia, China, India, USA, Japan, GB/UK, Schuko / Adaptateur-interrupteur 16A, standard standard Euro 2Pin, Australie, Chine, Inde, USA, Japon, GB/UK, Schuko
- F. Caricatore USB / USB charger / Chargeur USB
- G. Scaricatore sovratensioni / Surge arrester / Limiteur de surtension.

A
cod. 994491



B
cod. 994497

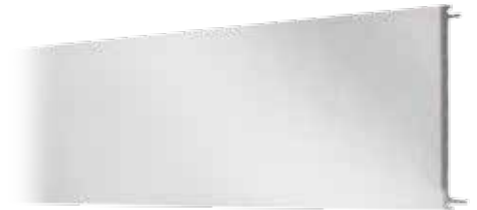

C
cod. 994492



D
cod. 994493



E
cod. 994494



F
cod. 994495



G
cod. 994496



Disponibile nelle finiture:
Available in finishes:
Disponibile dans les finitions:

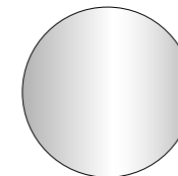

Alluminio opaco
Matt aluminium
Aluminium mat

Illuminazione

Lighting
Éclairage



Illuminazione

— *Basi, pensili, colonne / Base, wall and tall units / Éléments bas, hauts et armoires*



Lampada Kiton / Kiton light / Éclairage Kiton

Per cestone e base anta / For jumbo drawer and base unit with door / Pour casserolier et élément bas avec porte.
Con sensore incorporato / With integrated sensor / Avec détecteur incorporé.
3000 °K - 4000 °K Led.

cod. 991F65 (41,3 cm)
cod. 991F66 (56,3 cm)
cod. 991F67 (71,3 cm)
cod. 991F69 (86,3 cm)
cod. 991F61 (101,3 cm)
cod. 991F62 (116,3 cm)

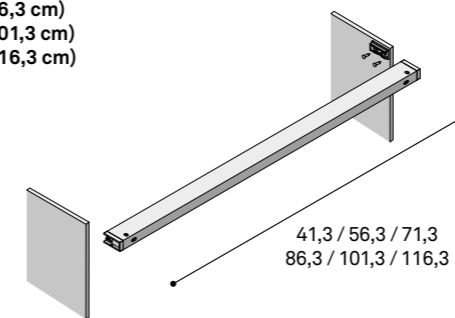

Lampada Malindi / Malindi light / Éclairage Malindi

Per incasso interno mobile / For recessing inside the cabinet / Il s'encastre à l'intérieur d'un meuble.
Con sensore incorporato / With integrated sensor / Avec détecteur incorporé.
3000 °K - 4000 °K Led ad alta efficienza / 3000 °K - 4000 °K high-efficiency Led / Leds 3000 °K - 4000 °K haute efficacité.

cod. 991E15 (37,2 cm)
cod. 991E16 (50 cm)
cod. 991E19 (76 cm)
cod. 991E12 (100 cm)
cod. 991E10 (190 cm)

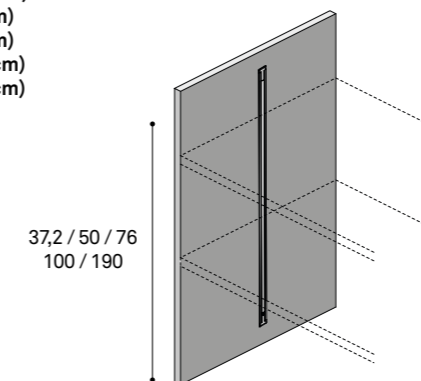

Illuminazione

— Basi, pensili, colonne / Base, wall and tall units / Éléments bas, hauts et armoires

Lampada Malindi / Malindi light / Éclairage Malindi

Per incasso fondo pensili o mensole / To be recessed into the bottom panel of eall units or in shelves / À encastrer sous les él. hauts ou sous les étagères. Con o senza interruttore a infrarossi / With or without infrared switch / Avec ou sans interrupteur à infrarouges.

Disponibile nella versione al metro lineare / Available in the version per linear metre / Disponible en version au mètre linéaire.
3000 °K - 4000 °K Led ad alta efficienza / 3000 °K - 4000 °K high-efficiency Led / 3000 °K - 4000 °K haute efficacité.

cod. 991E35 / 991E25 (37,2 cm)
cod. 991E36 / 991E26 (50 cm)
cod. 991E39 / 991E29 (76 cm)
cod. 991E32 / 991E22 (100 cm)

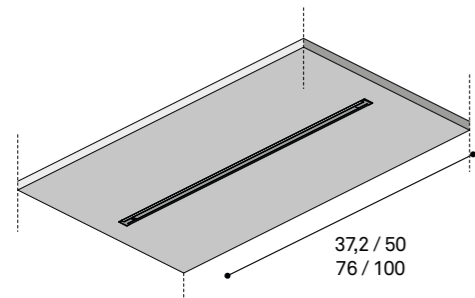

Illuminazione

— Basi, pensili, colonne / Base, wall and tall units / Éléments bas, hauts et armoires

Lampada Bali / Bali light / Éclairage Bali

Per telaio scolapiatti / For dish-drainer frame / Pour structure égouttoir.

Con interruttore a infrarossi e alimentatore / With infrared switch and power supply / Avec interrupteur à infrarouges et avec alimentation. Grado di protezione IP 43 / IP 43 protection marking / Indice de protection IP 43.

3000 °K - 4000 °K Led ad alta efficienza / 3000 °K - 4000 °K high-efficiency Led / Leds 3000 °K - 4000 °K haute efficacité.

cod. 991E76 (56,3 cm) cod. 991E70 (101,3 cm)
cod. 991E77 (71,3 cm) cod. 991E72 (116,3 cm)
cod. 991E79 (86,3 cm)

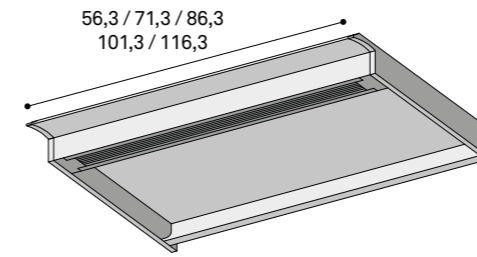

Lampada Oslo / Oslo light / Éclairage Oslo

Per apertura pensile con profilo / For doors with grip recess / Pour ouverture avec profil.

Interruttore a infrarossi / Infrared switch / Interrupteur à infrarouges.

3000 °K - 4000 °K Led.

cod. 991B15 / 991D15 (41,3 cm)
cod. 991B16 / 991D16 (56,3 cm)
cod. 991B17 / 991D17 (71,3 cm)
cod. 991B19 / 991D19 (86,3 cm)
cod. 991B10 / 991D10 (101,3 cm)
cod. 991B12 / 991D12 (116,3 cm)

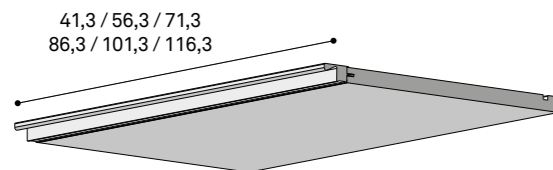

Lampada Skuba / Skuba light / Éclairage Skuba

Per scolapiatti / For dish-drainer / Pour égouttoir.

Grado di protezione IP 43 / IP 43 protection marking / Indice de protection IP 43.

4000 °K Led ad alta efficienza / 4000 °K high-efficiency Led / 4000 °K haute efficacité.

cod. 991B25 (48 cm)
cod. 991B27 (66,3 cm)
cod. 991B29 (84,6 cm)

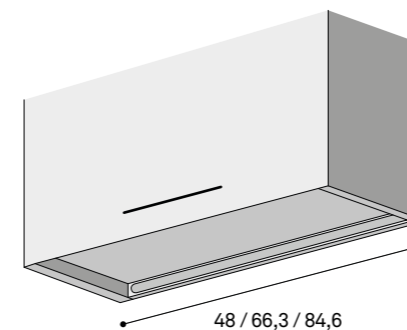

Illuminazione

— Basi, pensili, colonne / Base, wall and tall units / Éléments bas, hauts et armoires

Lampada Lugano / Lugano light / Éclairage Lugano

Per incasso sottopensile, non posizionare in corrispondenza di scolapiatti / Must be recessed below wall units. Not available for dish-drainer units / Il s'encastre sous l'élément haut. Ne pas installer sous l'élément avec égouttoir à vaisselle. Con o senza interruttore a infrarossi / With or without infrared switch / Avec ou sans interrupteur à infrarouges. Disponibile nella versione al metro lineare / Available in the version per linear metre / Disponible en version au mètre linéaire. 3000 °K - 4000 °K Led ad alta efficienza / 3000 °K - 4000 °K high-efficiency Led / 3000 °K - 4000 °K haute efficacité.

cod. 991E35 / 991E25 (37,2 cm)
cod. 991E36 / 991E26 (50 cm)
cod. 991E39 / 991E29 (76 cm)
cod. 991E32 / 991E22 (100 cm)

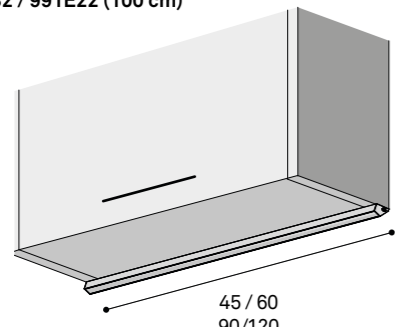

Lampada Fly Light / Fly Light light / Éclairage Fly Light

Per ripiani vetro / For glass shelves / Pour tablettes en verre.
3000 °K - 4000 °K Led ad alta efficienza / 3000 °K - 4000 °K high-efficiency Led / Leds 3000 °K - 4000 °K haute efficacité.

cod. 991B05 / 991D05 (41,3 cm)
cod. 991B06 / 991D06 (56,3 cm)
cod. 991B09 / 991D09 (86,3 cm)
cod. 991B02 / 991D02 (116,3 cm)

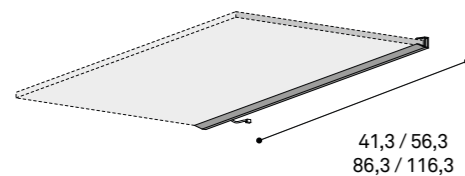

Illuminazione

— Basi, pensili, colonne / Base, wall and tall units / Éléments bas, hauts et armoires

Faretto Easy / Easy spotlight / Spot à leds Easy

Da incasso / Recessed / À encastrer.
Con interruttore a ON-OFF / With ON-OFF switch / Avec interrupteur ON-OFF.
4000 °K Led ad alta efficienza / 4000 °K high efficiency Led / Leds 4000 °K haute efficacité.

cod. 991130

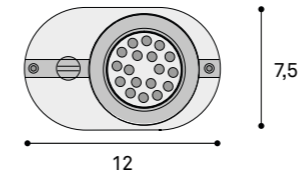

Faretto Kuomi / Kuomi spotlight / Spot à leds Kuomi

Da incasso / Recessed / À encastrer.
3000 °K - 4000 °K Led ad alta efficienza / 3000 °K - 4000 °K high-efficiency Led / Leds 3000 °K - 4000 °K haute efficacité.

cod. 991310 / 991311

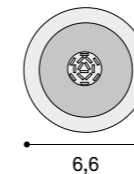

Illuminazione

— *Basi, pensili, colonne / Base, wall and tall units / Éléments bas, hauts et armoires*

Striscia led Strip Reel / Strip Reel light stripe / Ruban à leds Stripreel

Lunghezza massima 5 mt / Maximum length 5 mt / Longueur maximale.

4.000 °K Led ad alta efficienza / 4.000 °K high efficiency Led / Leds 4000°K haute efficacité.

cod. 991B50



Tavoli e Sostegni penisola

Tables and support for breakfast bar

Tables et piètement pour plan



Lignum

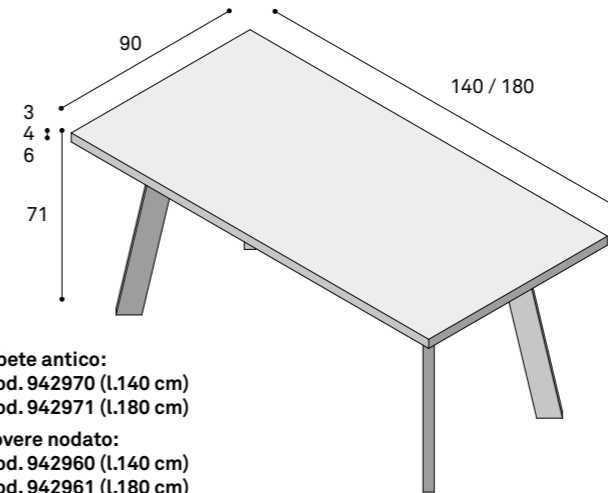

abete antico:
cod. 942970 (L.140 cm)
cod. 942971 (L.180 cm)
rovere nodato:
cod. 942960 (L.140 cm)
cod. 942961 (L.180 cm)

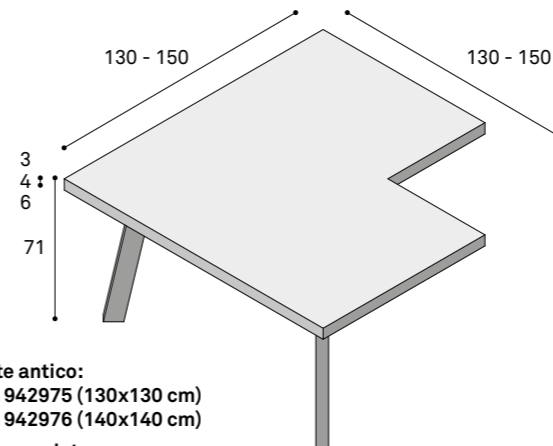

abete antico:
cod. 942975 (130x130 cm)
cod. 942976 (140x140 cm)
rovere nodato:
cod. 942965 (130x130 cm)
cod. 942966 (140x140 cm)

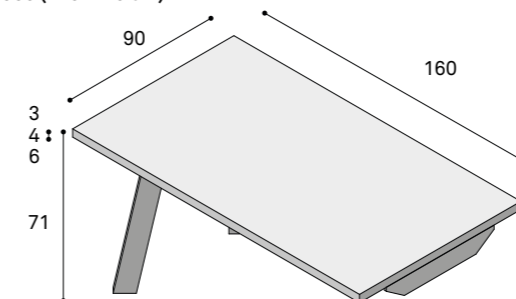

abete antico: cod. 942977
rovere nodato: cod. 942967

Disponibile nelle finiture:
Available in finishes:
Disponibile dans les finitions:



Abete antico



Rovere nodato



Keta — Design García Cumini

Sostegno per piani penisola / Support for breakfast bar / Piètement pour plan

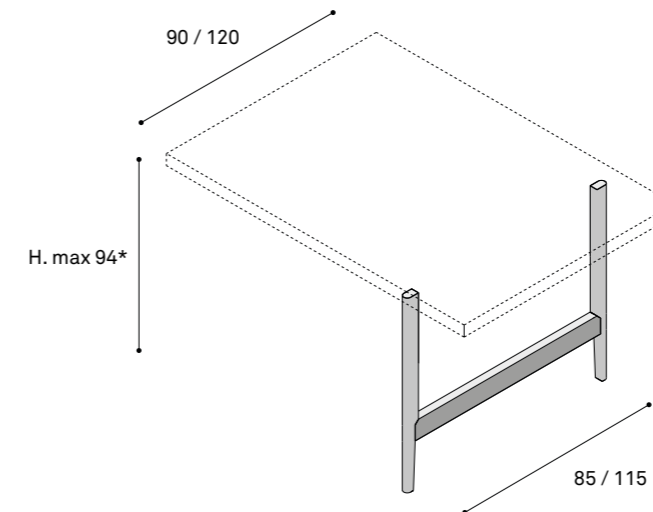

Bar top not included. The height can vary depending on the thickness of the top and the height of the plinths.

* Top escluso. H. variabile in base allo spessore del top e all'altezza degli zoccoli.

Bar top not included. The height can vary depending on the thickness of the top and the height of the plinths.

Hors plan. H. variable en fonction de l'épaisseur du plan et de la hauteur des socles.

Laccato seta:
cod. 992050 (per piano l.90)
cod. 992051 (per piano l.120)

Rovere termocotto:
cod. 992060 (per piano l.90)
cod. 992061 (per piano l.120)

Essenza rovere:
cod. 992070 (per piano l.90)
cod. 992071 (per piano l.120)

Disponibile nelle finiture:
Available in finishes:
Disponible dans les finitions:

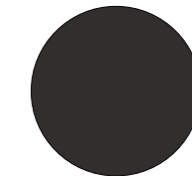

Laccati seta
Silk-effect lacquers
Laques brillantes et soie



Rovere Termocotto



Essenze Rovere
Wood Rovere
Essence Rovere

Sostegni

Per piani penisola / Support for breakfast bar / Piètement pour plan



Sostegno per piano penisola
Stainless steel support for breakfast bar
Piètement pour plan agencé en épi

Disponibile nelle finiture:
Available in finishes:
Disponibile dans les finitions:

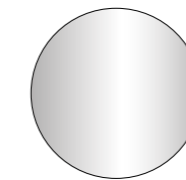

Acciaio inox
Stainless steel
Acier inox

cod. 987050

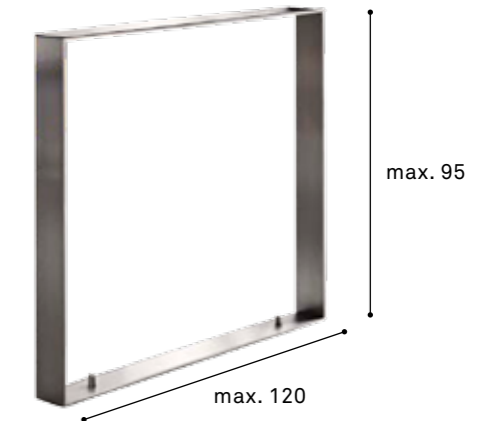

Gambone quadro per penisola
Oblong penisular unit leg
Pied carré pour plan agencé en épi

Disponibile nelle finiture:
Available in finishes:
Disponibile dans les finitions:

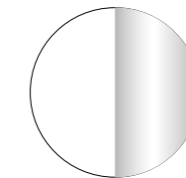

Cromato / Verniciato
bianco
Chromed / White
lacquered
Chromé / Laqué blanc

cod. 992126 (cromato)
cod. 992127 (bianco)



Gambone alluminio Ø12 per penisola /
Ø12 aluminium leg for breakfast bar
Pied en aluminium Ø12 pour plan
agencé en épi

Disponibile nelle finiture:
Available in finishes:
Disponibile dans les finitions:

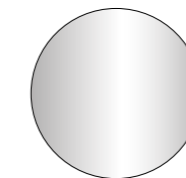

Alluminio
Aluminium
Aluminium

cod. 992011

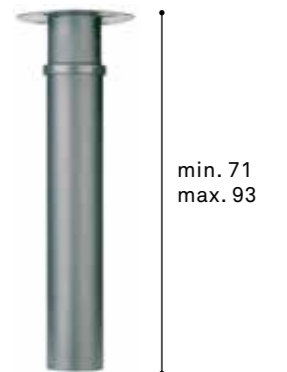

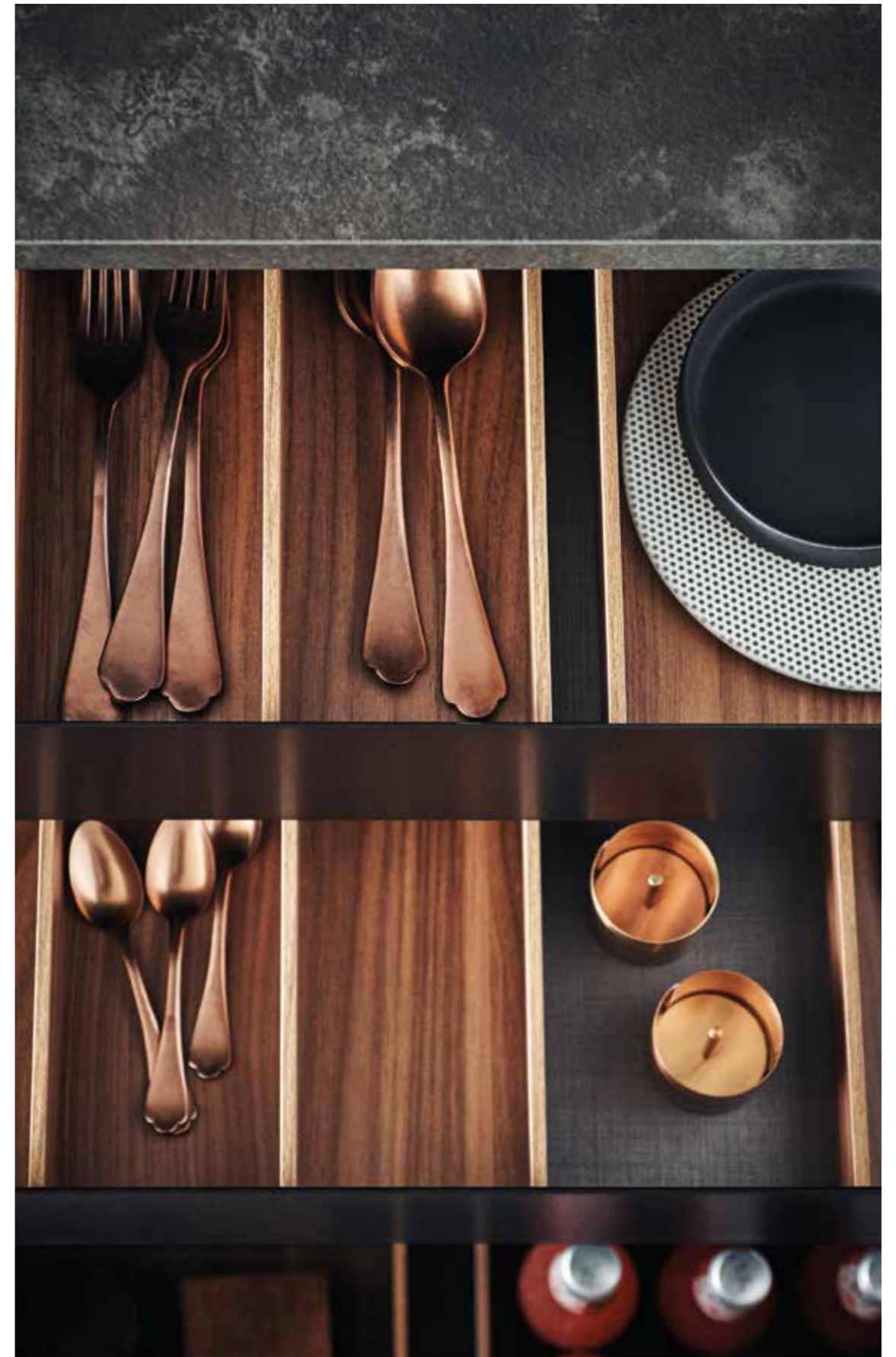

PHOTOGRAPHY: ANDREA FERRARI
STYLING PROJECT: STUDIOPEPE
POSTPRODUCTION: NUMERIQUE.IT
(pp. 02, 05, 06, 10, 14, 18, 28, 34, 40, 46, 55, 56, 69, 77, 79, 82, 86, 87)

PHOTOGRAPHY: CONTRATTICOMPANY
STYLING PROJECT: DORIS ANDREUTTI
(pp. 33, 80, 84)

STAMPA: GRAFICHE GFP / SETTEMBRE 2017

PAPER PRINTED FSC® CERTIFIED:



> Questo materiale è di proprietà di Cesar Arredamenti Spa. Le informazioni in esso contenute sono strettamente riservate, ne è vietata la diffusione, la riproduzione e l'uso non autorizzato. Gli articoli presentati in questo catalogo sono una selezione di prodotti della collezione Cesar. Dimensioni e codici fanno riferimento al listino Cesar ed. 2017, strumento da consultare per qualsiasi ulteriore informazione.
Cesar Arredamenti Spa si riserva il diritto di apportare, senza preavviso, eventuali modifiche necessarie per il miglioramento funzionale ed estetico dei propri prodotti.

> This material belongs to Cesar Arredamenti Spa. The information contained in it is strictly confidential: its diffusion, reproduction and non-authorized use are prohibited. In this catalog is presented a selection of articles of Cesar's collection. Dimensions and codes refer to Cesar Price List ed. 2017 tool to be consulted for any further information. Cesar Arredamenti Spa is entitled to make any modifications deemed essential to improve the functionality or aesthetics of its products without giving prior notice.

> Ce matériel est la propriété de Cesar Arredamenti Spa. Les informations qu'il contient sont strictement confidentielles. Leur diffusion, leur reproduction et leur utilisation non autorisée sont interdites. Les articles présentés en ce catalogue sont partie d'une sélection des produits de la collection Cesar. Les dimensions et les codes font référence au Tarif Cesar ed. 2017, outil à consulter pour toutes les informations ultérieures.
Cesar Arredamenti Spa se réserve le droit d'apporter, sans aucun préavis, toutes les modifications nécessaires à l'amélioration fonctionnelle et esthétique de ses produits.

Cesar Arredamenti Spa

Via Cav. Vittorio Veneto 1/3
30020 Pramaggiore (VE) Italy
T. +39 0421 2021
F. +39 0421 200059
info@cesar.it / www.cesar.it